

N-Channel 150-V (D-S) MOSFET

Key Features:

- Low $r_{DS(on)}$ trench technology
- Low thermal impedance
- Fast switching speed

Typical Applications:

- LED Inverter Circuits
- Inrush Limiter and Hot Swap Circuits
- 48V-Input DC/DC Conversion Circuits

PRODUCT SUMMARY		
V_{DS} (V)	$r_{DS(on)}$ (m Ω)	I_D (A)
150	22 @ $V_{GS} = 10V$	80 ^a
	27 @ $V_{GS} = 6.5V$	



RoHS
COMPLIANT
HALOGEN
FREE

TO-247

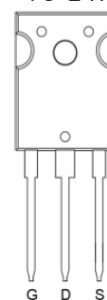

DRAIN
connected
to TAB

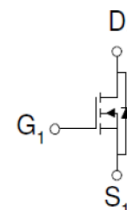

N-Channel MOSFET

ABSOLUTE MAXIMUM RATINGS ($T_A = 25^\circ\text{C}$ UNLESS OTHERWISE NOTED)

Parameter	Symbol	Limit	Units
Drain-Source Voltage	V_{DS}	150	V
Gate-Source Voltage	V_{GS}	± 20	
Continuous Drain Current ^a	I_D	80	A
Pulsed Drain Current ^b	I_{DM}	320	
Continuous Source Current (Diode Conduction) ^a	I_S	80	A
Power Dissipation ^a	P_D	500	W
Operating Junction and Storage Temperature Range	T_J, T_{stg}	-55 to 175	$^\circ\text{C}$

THERMAL RESISTANCE RATINGS

Parameter	Symbol	Maximum	Units
Maximum Junction-to-Ambient ^c	$R_{\theta JA}$	40	$^\circ\text{C/W}$
Maximum Junction-to-Case	$R_{\theta JC}$	0.29	

Notes

- Package Limited
- Pulse width limited by maximum junction temperature
- Surface Mounted on 1" x 1" FR4 Board.

Electrical Characteristics

Parameter	Symbol	Test Conditions	Min	Typ	Max	Unit
Static						
Gate-Source Threshold Voltage	$V_{GS(th)}$	$V_{DS} = V_{GS}, I_D = 250 \mu A$	1			V
Gate-Body Leakage	I_{GSS}	$V_{DS} = 0 V, V_{GS} = \pm 20 V$			± 100	nA
Zero Gate Voltage Drain Current	I_{DSS}	$V_{DS} = 120 V, V_{GS} = 0 V$			1	uA
		$V_{DS} = 120 V, V_{GS} = 0 V, T_J = 55^\circ C$			10	
On-State Drain Current ^a	$I_{D(on)}$	$V_{DS} = 5 V, V_{GS} = 10 V$	100			A
Drain-Source On-Resistance ^a	$r_{DS(on)}$	$V_{GS} = 10 V, I_D = 40 A$			22	mΩ
		$V_{GS} = 6.5 V, I_D = 30 A$			27	
Forward Transconductance ^a	g_{fs}	$V_{DS} = 15 V, I_D = 40 A$		56		S
Diode Forward Voltage ^a	V_{SD}	$I_S = 40 A, V_{GS} = 0 V$		0.93		V
Dynamic ^b						
Total Gate Charge	Q_g	$V_{DS} = 75 V, V_{GS} = 6.5 V,$ $I_D = 40 A$		32		nC
Gate-Source Charge	Q_{gs}			12		
Gate-Drain Charge	Q_{gd}			12		
Turn-On Delay Time	$t_{d(on)}$	$V_{DS} = 75 V, R_L = 1.9 \Omega,$ $I_D = 40 A,$ $V_{GEN} = 10 V, R_{GEN} = 6 \Omega$		27		ns
Rise Time	t_r			29		
Turn-Off Delay Time	$t_{d(off)}$			60		
Fall Time	t_f			40		
Input Capacitance	C_{iss}	$V_{DS} = 50 V, V_{GS} = 0 V, f = 1 Mhz$		2354		pF
Output Capacitance	C_{oss}			577		
Reverse Transfer Capacitance	C_{rss}			418		

Notes

- Pulse test: PW ≤ 300us duty cycle ≤ 2%.
- Guaranteed by design, not subject to production testing.

Analog Power (APL) reserves the right to make changes without further notice to any products herein. APL makes no warranty, representation or guarantee regarding the suitability of its products for any particular purpose, nor does APL assume any liability arising out of the application or use of any product or circuit, and specifically disclaims any and all liability, including without limitation special, consequential or incidental damages. "Typical" parameters which may be provided in APL data sheets and/or specifications can and do vary in different applications and actual performance may vary over time. All operating parameters, including "Typicals" must be validated for each customer application by customer's technical experts. APL does not convey any license under its patent rights nor the rights of others. APL products are not designed, intended, or authorized for use as components in systems intended for surgical implant into the body, or other applications intended to support or sustain life, or for any other application in which the failure of the APL product could create a situation where personal injury or death may occur. Should Buyer purchase or use APL products for any such unintended or unauthorized application, Buyer shall indemnify and hold APL and its officers, employees, subsidiaries, affiliates, and distributors harmless against all claims, costs, damages, and expenses, and reasonable attorney fees arising out of, directly or indirectly, any claim of personal injury or death associated with such unintended or unauthorized use, even if such claim alleges that APL was negligent regarding the design or manufacture of the part. APL is an Equal Opportunity/Affirmative Action Employer.

Typical Electrical Characteristics

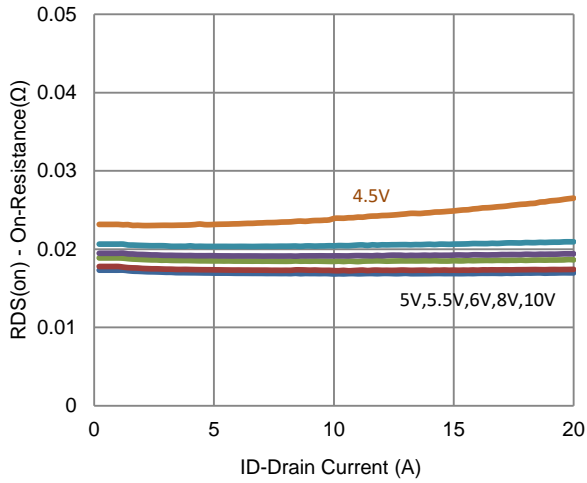

1. On-Resistance vs. Drain Current

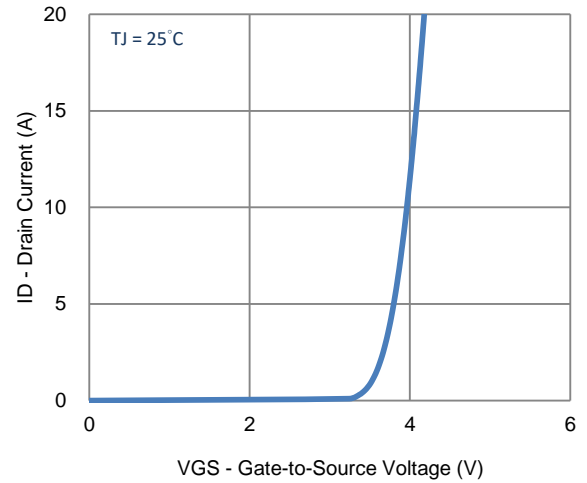

2. Transfer Characteristics

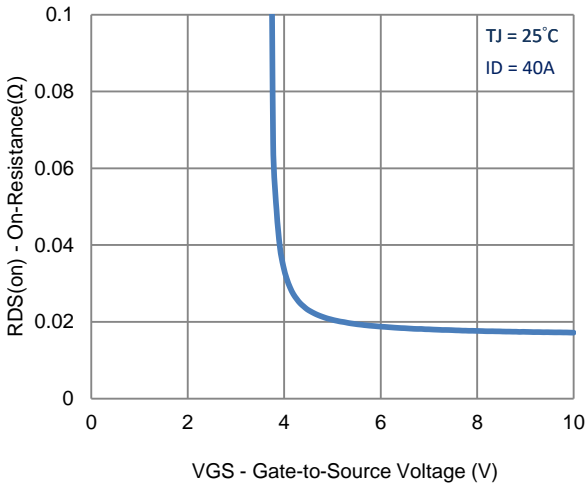

3. On-Resistance vs. Gate-to-Source Voltage

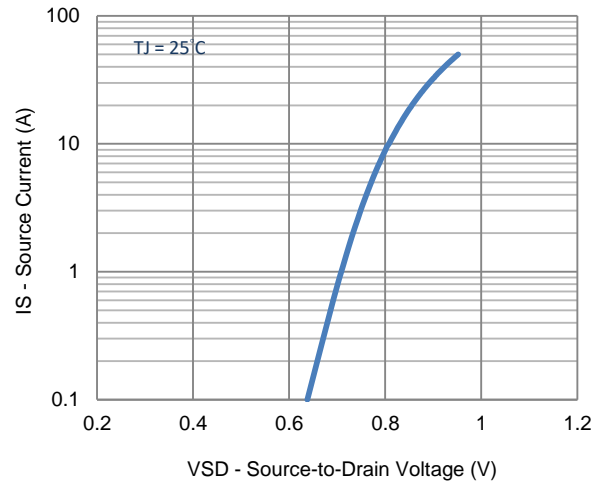

4. Drain-to-Source Forward Voltage

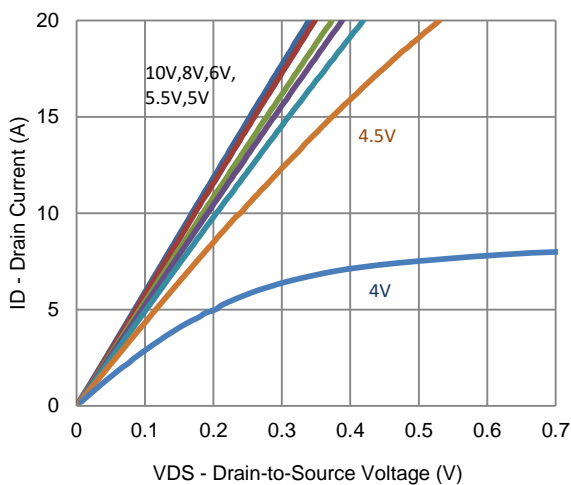

5. Output Characteristics

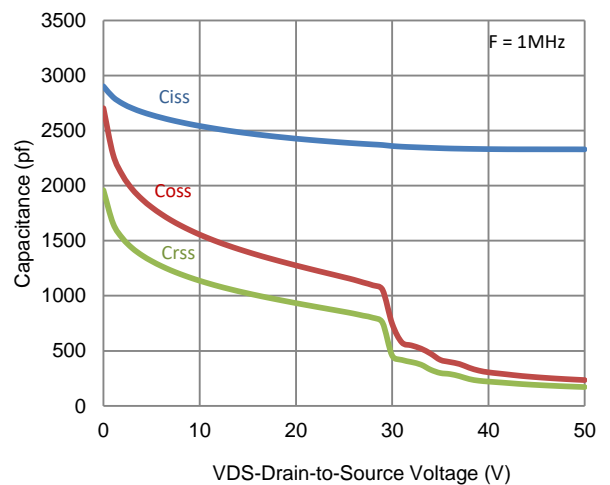

6. Capacitance

Typical Electrical Characteristics

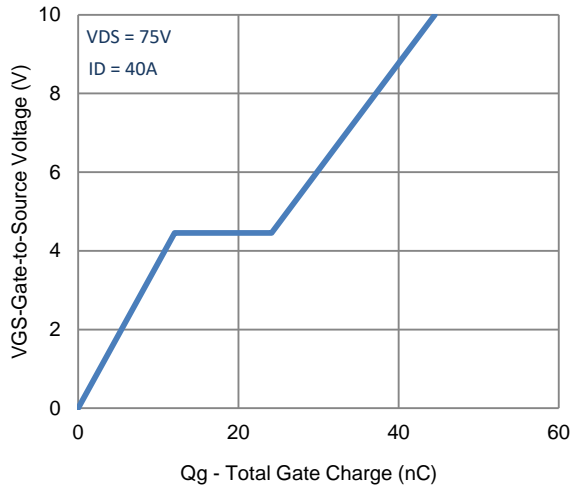

7. Gate Charge

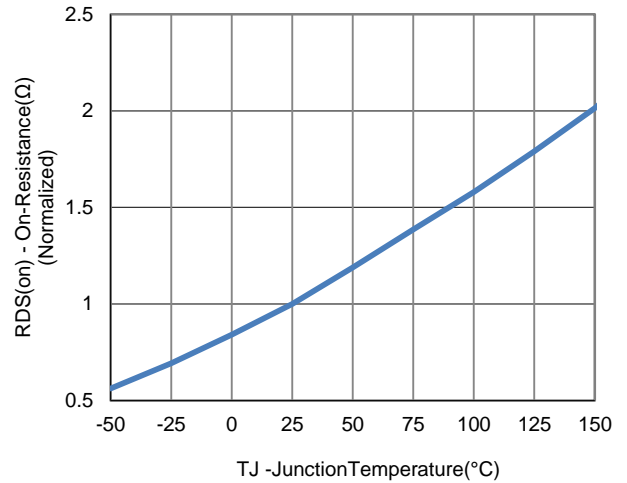

8. Normalized On-Resistance Vs Junction Temperature

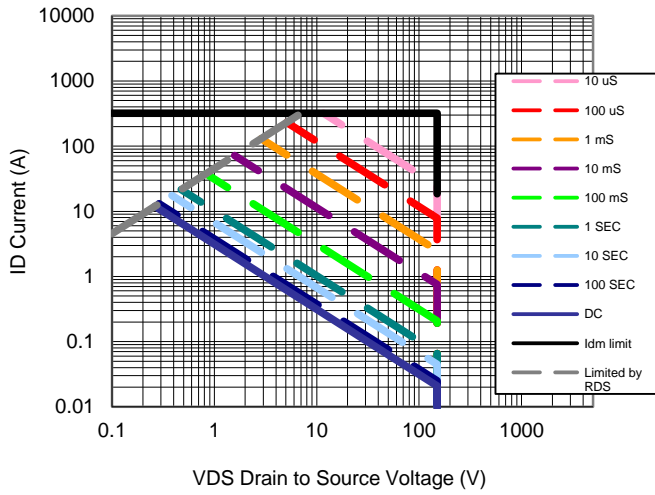

9. Safe Operating Area

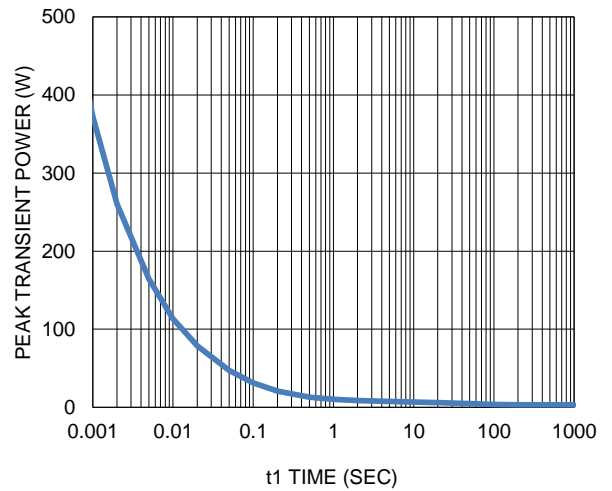

10. Single Pulse Maximum Power Dissipation

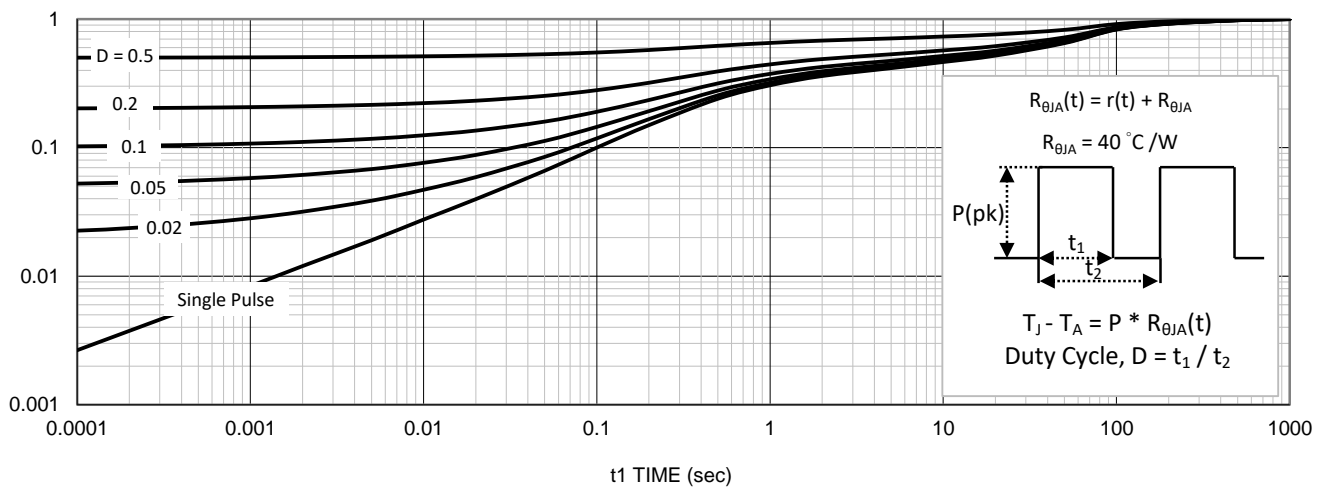

11. Normalized Thermal Transient Junction to Ambient

Package Information

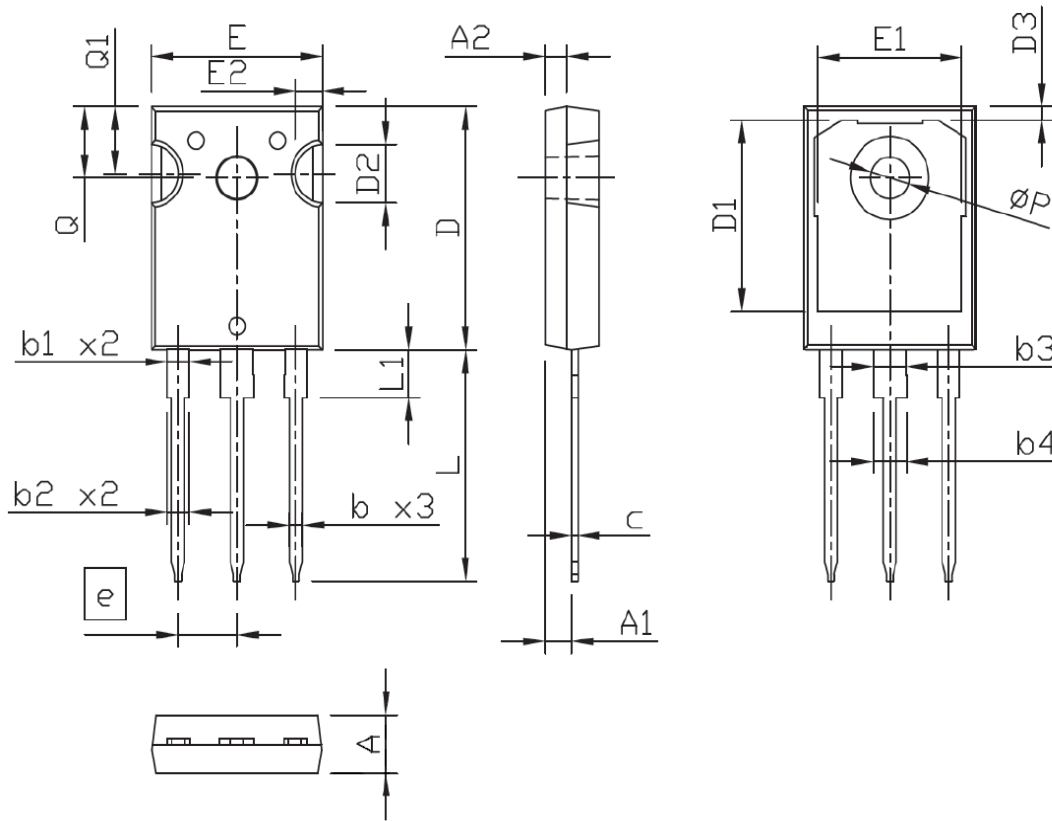

SYMBOLS	DIMENSIONS IN MILLIMETERS		
	MIN	NOM	MAX
A	4.90	5.00	5.10
A1	2.32	2.42	2.52
A2	1.90	2.00	2.10
b	1.17	1.22	1.27
b1	1.97	2.02	2.07
b2	2.00	2.10	2.20
b3	2.97	3.02	3.07
b4	3.00	3.10	3.20
c	0.59	0.62	0.66
D	20.90	21.00	21.10
D1	16.25	16.55	16.85
D2	5.00 TYP		
D3	1.05	1.20	1.35
e	5.44 BSC		
E	15.70	15.80	15.90
E1	13.06	13.26	13.46
E2	2.50 TYP		
L	19.72	19.92	20.12
L1	---	---	4.30
Q	6.15 BSC		
Q1	5.60	5.80	6.00
ØP	3.55	3.60	3.65