

1200-V Direct WBG Diode

Key Features:

- SiC performance
- Easy paralleling
- High current carrying capability
- Very low junction capacitance
- Highly stable V_F and Q_{RR} at elevated temperatures

Typical Applications:

- Soft switching topologies
- Secondary side rectification

PRODUCT SUMMARY		
V_{BR} (V)	V_F (V)	$I_{F(AV)}$ (A)
1200	1.8	10



RoHS
COMPLIANT
HALOGEN
FREE

TO-247-3L



Case

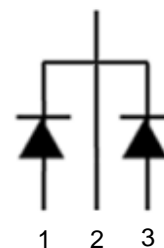

ABSOLUTE MAXIMUM RATINGS ($T_A = 25^\circ\text{C}$ UNLESS OTHERWISE NOTED)

Parameter	Symbol	Limit	Units
Cathode-Anode Voltage	V_{BR}	1200	V
Diode Forward Current ^a	$I_{F(AV)}$	10 / 20	A
Single Pulse Forward Current ^b	I_{FSM}	50	A
Joule Integral	i^2t	12	A ² ·s
Power Dissipation ^a	P_D	18.5 / 37	W
Storage Temperature Range	T_{stg}	-55 to 175	°C
Operating Junction Temperature	T_J	-40 to 175	°C

THERMAL RESISTANCE RATINGS

Parameter	Symbol	Maximum	Units
Maximum Junction-to-Ambient ^c	$R_{\theta JA}$	40	°C/W
Maximum Junction-to-Case	$R_{\theta JC}$	8.2 / 4.1	

Notes

- Package Limited
- Pulse width limited by maximum junction temperature
- Surface Mounted on 1" x 1" FR4 Board.

Electrical Characteristics

Parameter	Symbol	Test Conditions	Min	Typ	Max	Unit
Static						
Forward Voltage ^a	V_F	$I_F = 10\text{ A}$		1.8		V
		$I_F = 10\text{ A}, T_J = 120^\circ\text{C}$		1.84		
Repetitive Peak Reverse Voltage	V_{RRM}	$T_J = -40^\circ\text{C to } 120^\circ\text{C}$	1200			V
Junction Capacitance	C_J	$V_R = 200\text{ V}, V_{\text{sine}} = 0.6 V_{\text{eff}},$ $f = 100\text{ kHz}$		6.3		pF
Reverse Leakage Current	I_R	$V_R = 1200\text{ V}$			2	uA
		$V_R = 1200\text{ V}, T_J = 120^\circ\text{C}$			10	uA
Dynamic ^b						
Reverse Recovery Time	T_{rr}	$I_F = 10\text{ A}, dI/dt = 100\text{ A/us},$ $T_J = 25^\circ\text{C}$		80		ns
Reverse Recovery Charge	Q_{rr}			157		nC
Peak Recovery Current	I_{RRM}			3.3		A
Reverse Recovery Time	T_{rr}	$I_F = 10\text{ A}, dI/dt = 100\text{ A/us},$ $T_J = 120^\circ\text{C}$		75		ns
Reverse Recovery Charge	Q_{rr}			127		nC
Peak Recovery Current	I_{RRM}			2.8		A
Reverse Recovery Time	T_{rr}	$I_F = 10\text{ A}, dI/dt = 500\text{ A/us},$ $T_J = 25^\circ\text{C}$		32		ns
Reverse Recovery Charge	Q_{rr}			215		nC
Peak Recovery Current	I_{RRM}			11.2		A
Reverse Recovery Time	T_{rr}	$I_F = 10\text{ A}, dI/dt = 500\text{ A/us},$ $T_J = 120^\circ\text{C}$		32		ns
Reverse Recovery Charge	Q_{rr}			193		nC
Peak Recovery Current	I_{RRM}			9.9		A

Notes

- Pulse test: PW <= 300us duty cycle <= 2%.
- Guaranteed by design, not subject to production testing.

Analog Power (APL) reserves the right to make changes without further notice to any products herein. APL makes no warranty, representation or guarantee regarding the suitability of its products for any particular purpose, nor does APL assume any liability arising out of the application or use of any product or circuit, and specifically disclaims any and all liability, including without limitation special, consequential or incidental damages. "Typical" parameters which may be provided in APL data sheets and/or specifications can and do vary in different applications and actual performance may vary over time. All operating parameters, including "Typicals" must be validated for each customer application by customer's technical experts. APL does not convey any license under its patent rights nor the rights of others. APL products are not designed, intended, or authorized for use as components in systems intended for surgical implant into the body, or other applications intended to support or sustain life, or for any other application in which the failure of the APL product could create a situation where personal injury or death may occur. Should Buyer purchase or use APL products for any such unintended or unauthorized application, Buyer shall indemnify and hold APL and its officers, employees, subsidiaries, affiliates, and distributors harmless against all claims, costs, damages, and expenses, and reasonable attorney fees arising out of, directly or indirectly, any claim of personal injury or death associated with such unintended or unauthorized use, even if such claim alleges that APL was negligent regarding the design or manufacture of the part. APL is an Equal Opportunity/Affirmative Action Employer.

Typical Electrical Characteristics

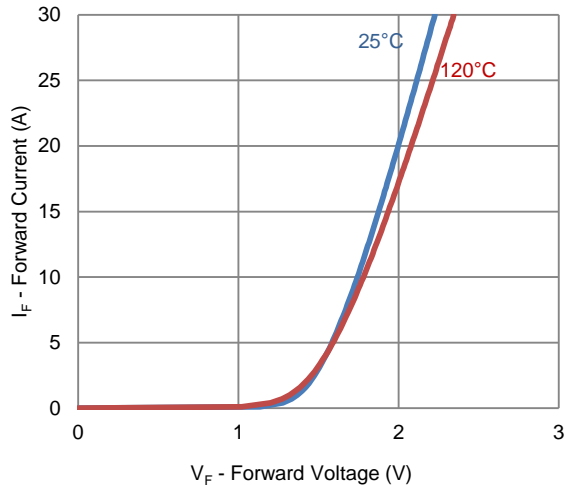

1. Forward Characteristics

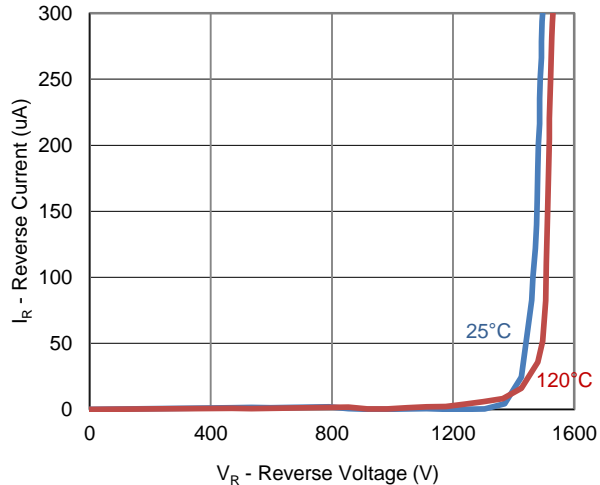

2. Reverse Characteristics

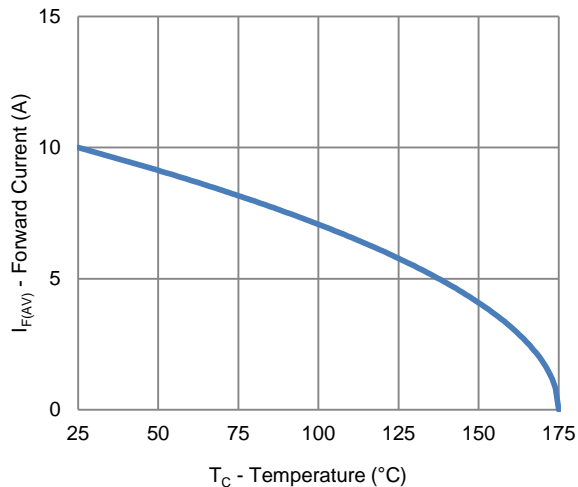

3. Current Derating

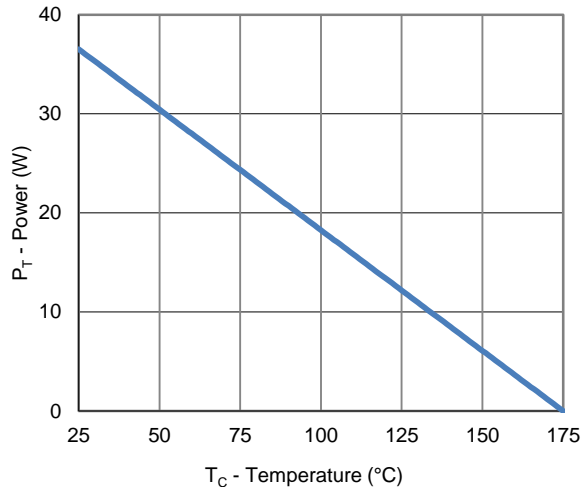

4. Power Derating

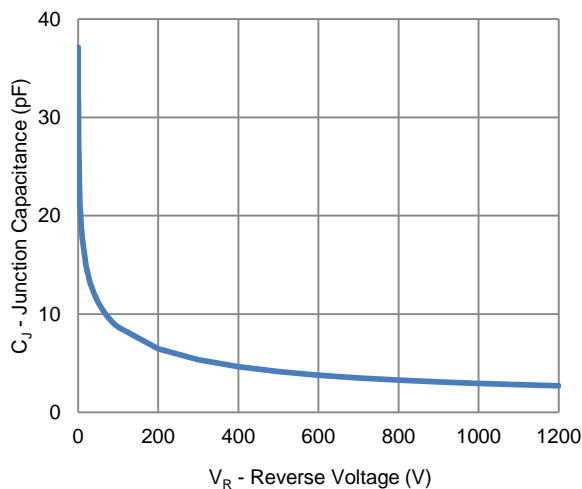

5. Junction Capacitance vs. Reverse Voltage

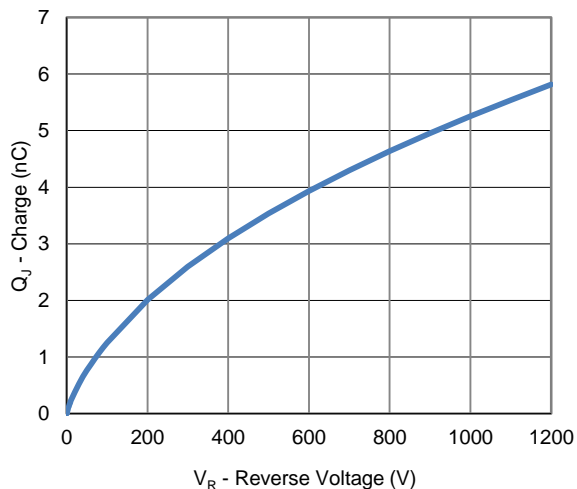

6. Total Capacitance Charge vs. Reverse Voltage

Typical Electrical Characteristics

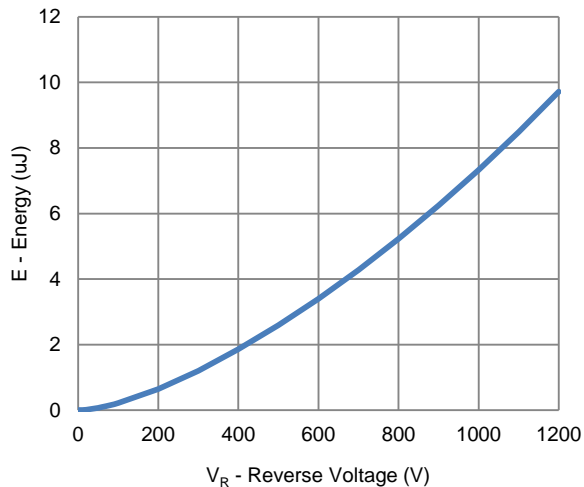

7. Capacitance Stored Energy vs. Reverse Voltage

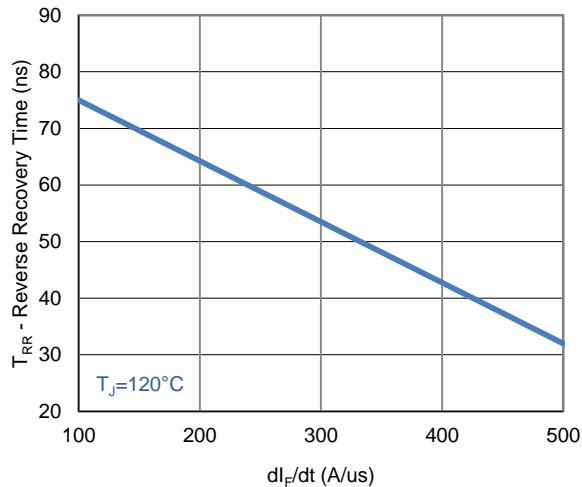

8. Reverse Recovery Time vs. di_F/dt

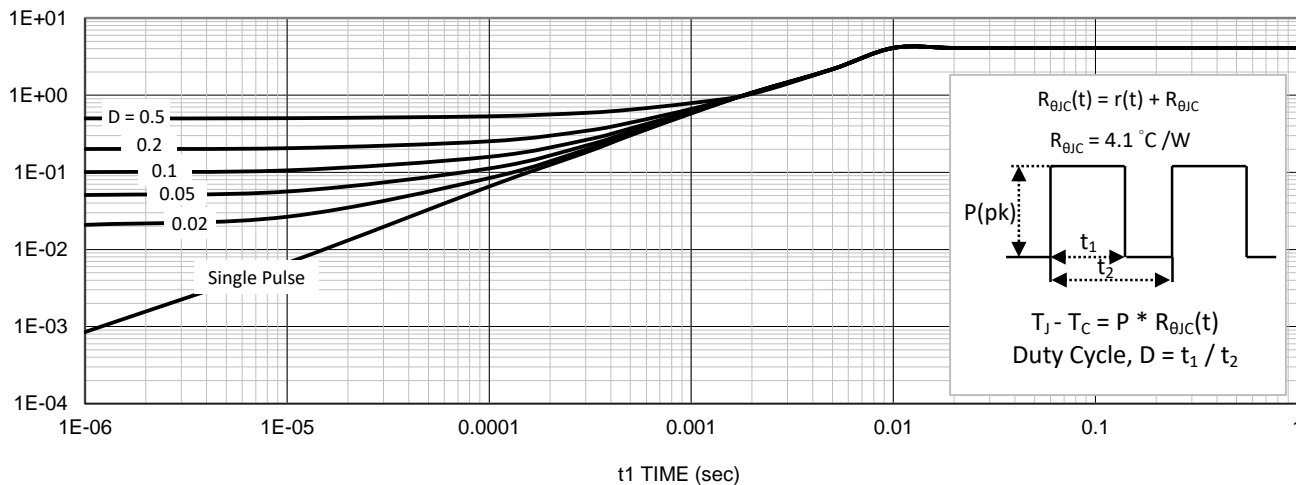

9. Thermal Transient Junction to Ambient

Package Information

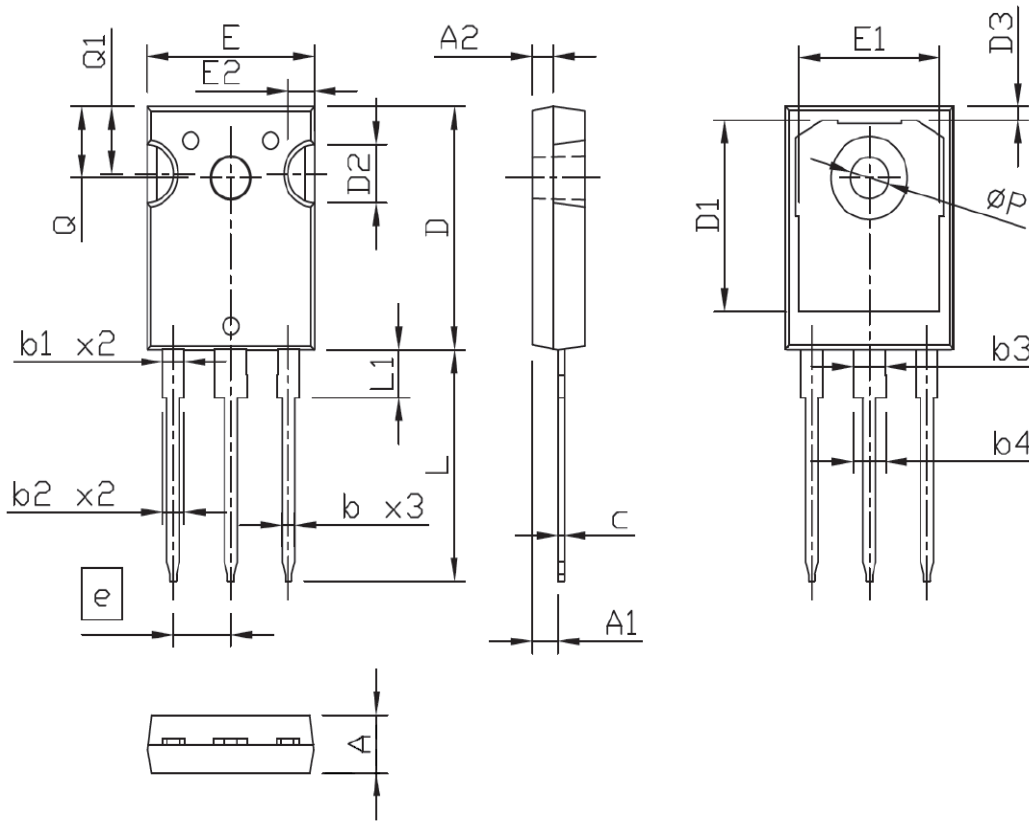

SYMBOLS	DIMENSIONS IN MILLIMETERS		
	MIN	NOM	MAX
A	4.90	5.00	5.10
A1	2.32	2.42	2.52
A2	1.90	2.00	2.10
b	1.17	1.22	1.27
b1	1.97	2.02	2.07
b2	2.00	2.10	2.20
b3	2.97	3.02	3.07
b4	3.00	3.10	3.20
c	0.59	0.62	0.66
D	20.90	21.00	21.10
D1	16.25	16.55	16.85
D2	5.00 TYP		
D3	1.05	1.20	1.35
e	5.44 BSC		
E	15.70	15.80	15.90
E1	13.06	13.26	13.46
E2	2.50 TYP		
L	19.72	19.92	20.12
L1	---	---	4.30
Q	6.15 BSC		
Q1	5.60	5.80	6.00
ØP	3.55	3.60	3.65